



HELLENIC REPUBLIC
 MINISTRY OF ECONOMY AND FINANCES
 MINISTRY OF INTERNAL AFFAIRS, PUBLIC
 ADMINISTRATION & DECENTRALIZATION

FRAMEWORK PROGRAMME
 «**INFORMATION SOCIETY**»



EUROPEAN UNION
EUROPEAN COMMISSION

THIS PROJECT HAS BEEN
 FUNDED AT 75% BY THE
 EUROPEAN REGIONAL
 DEVELOPMENT FUND
 (ERDF)

PROJECTS: **NETWORKING OF SCHOOL UNITS &
 TELEMATICS SERVICES FOR EDUCATION**

IMPLEMENTATION INSTITUTE:
MINISTRY OF NATIONAL EDUCATION AND RELIGIOUS AFFAIRS

Greek School Network

The network in the service of Education

<http://www.sch.gr>

1. What is the Greek Schools Network;

The Greek Schools' Network (GSN - www.sch.gr) is the educational intranet of the Ministry of Education and Religious Affairs (www.ypepth.gr), which interlinks all schools and provides basic and advanced telematics' services. Thus, it contributes to the creation of a new generation of educational communities, which takes advantage of the new Informatics' and Communication Technologies in the educational procedure.

The implementation of the Greek Schools' Network is funded by the Framework Programme for the Information Society (www.infosoc.gr), in close cooperation between the Ministry of Education as well as 12 Research Centers and Highest Education Institutes, specialized in network and Internet technologies.

2. Educational Exploitation of the Greek Schools Network

The current design and implementation of the Greek Schools Network focuses in providing useful services to all members of the basic and middle education community, fulfilling among others the following goals:

- Access to telecommunication and informatics services
- Access to digitized educational material
- Distance learning, e-learning
- Encourage collaboration
- Information and opinion exchange
- Conduct of thematic discussions, seminars, lectures, etc.
- Access to digital library services
- Communication and Cooperation of all educational degrees

- Communication with European educational networks
- Facilitate complimentary educational programs
- Provide education to individuals with special needs or disabilities
- Inform, educate, entertain

3. Network architecture

The network is hierarchically structured into three layers:

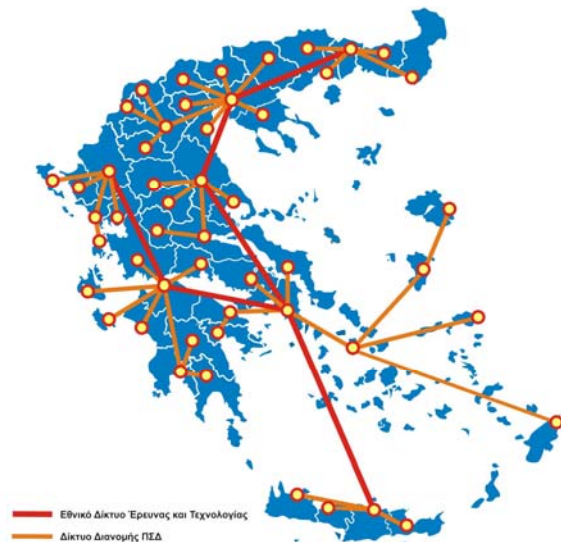

Core Network: The Greek Schools Network interconnects with the Greek Research and Technology Network (GRNET, www.grnet.gr), in seven main points (Athens, Thessaloniki, Patras, Heraclion, Larisa, Ioannina and Xanthi), using it as its core network.

Distribution Network: The Greek Schools Network installs in the capital of every prefecture network and computational equipment, thus ensuring optimal access of

the prefecture's school to the network and its services.

Access network: It is used to directly and efficiently interconnect the schools to the prefecture's access point. The telecommunication junctions used to interconnect each school are selected on the basis of financial and technical criteria from an array of available options:

- Digital ISDN circuit (bandwidth: 64 - 128 kbps)
- Analog leased line (0,128 - 2 Mbps)
- Public Switched Telephone Network circuit (56 kbps)
- Wireless link (10 Mbps)
- VDSL circuit (10 - 15 Mbps)
- ADSL circuit (384/128 Kbps, pilot implementation)

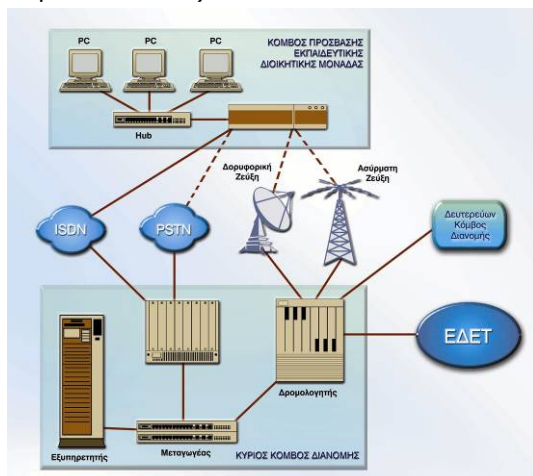

4. Users' categories

In order to maintain the educational orientation of the network, its users are certified individuals, educational or administrative entities of the National Education. In particular, the users are divided in the following categories:

- **Schools:** At least one user account have been provided to all middle grade education schools and 92% of first degree education schools.
- **Administrative units:** At least one user account has been provided to more than 2.282 administrative units of National Education.
- **Educational staff:** The Greek Schools Network offers fully personalized access to all educational staff, with the dial-up service being broadly used under certain terms.
- **Students:** Network access is provided to students through the school laboratories. In addition, pilot personalized access is offered to second grade students of Achaia and Corinthian Prefectures.

- **Administrative staff:** as with educational staff

5. Available Services

The Greek Schools Network offers a broad package of services to its units and users. The most important of these are:

1. Automated registration procedure for educational staff and students - Users Administration Service
2. Remote network access (dialup)
3. E-mail, accessible through the POP3 and IMAP protocols, as well as the world wide web www.sch.gr/mail
4. E-mail lists www.sch.gr/lists
5. Web Portal (www.sch.gr), offering news services and personalized access to telecommunication and informatics services
6. Controlled access to the World Wide Web, prohibiting access to web sites with harmful content for underage
7. Web hosting for static and dynamic pages
8. Wizards for automatic webpage creation
9. Asynchronous distance learning, for hosting and distributing digitized lessons (www.sch.gr/e-learning)
10. Teleconference www.sch.gr/conf
11. Video On Demand (www.sch.gr/vod), delivering streaming educational multimedia material
12. Live Internet transmission (webcasting) of various of various events (www.sch.gr/rts)
13. News (www.sch.gr/news) and Discussions (www.sch.gr/forums)
14. Electronic Magazine (www.sch.gr/magazine)
15. Personal Calendar, Personal Address Book, Notes and "To Do", accessible through the World Wide Web
16. Directory Service
17. GIS
18. Voice over IP
19. Online statistics (www.sch.gr/statistics)
20. Help-Desk, for immediate solution of technical problems. The Help-Desk is accessible through one-phone 801-11-801-81 and www.sch.gr/helpdesk

6. Networking progress

Currently, all educational and administrative units of the second educational degree are part of the Greek Schools Network, as well as (approximately) 96% of the first degree educational units (estimated time of completion: end of 2004)

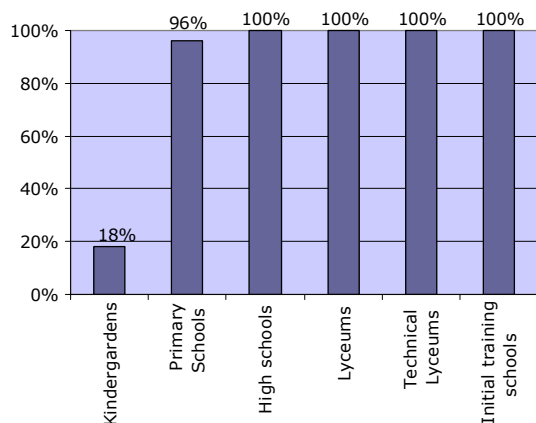

The Greek Schools Network Services have been broadly accepted by the educational community. A typical degree of usage is the number of e-mail accounts, which is constantly rising, as is evident by the next diagram. Another indication of this broad acceptance is the number of the web portal visitors (approximately 5.6 million during the last 35 months).

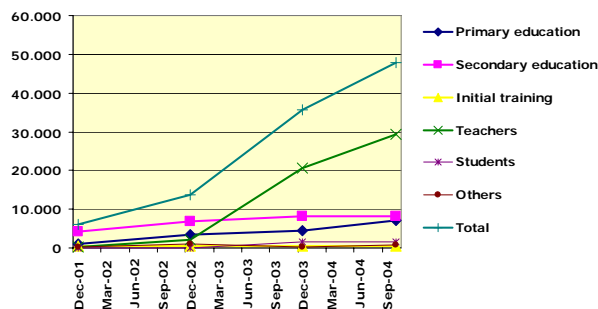

In order to facilitate the needs of the educational staff trained in Telecommunication and Informatics Technologies (<http://www.de.sch.gr/epimorfosi>), the Greek Schools Network offers personalized dialup accounts to the trainees, as well as the executive educational staff and Informatics professors. The number of personalized accounts is expected to reach a ceiling of 40,000 by the end of 2004.

The Greek Schools Network is also exploited to interconnect other important units, such as Public Libraries, Second Opportunity Schools, the General State Archives, etc.

7. Greek Schools Network and Broadband

In order to achieve the objectives of *e-Europe 2005* regarding provision of broadband access to all schools, the Greek Schools Network is upgrading its distribution network by installing broadband connections (installation of 500 ADSL connections, bandwidth 384/128 kbps, during the 1st phase, in addition to more than 250 wireless links, bandwidth 10 Mbps).

As far as wireless communications are concerned, 13 distinct wireless networks are in operation in the following cities: Athens (3 networks), Thessaloniki (2 networks), Kalamata, Siros, Volos, Xanthi, Kilkis, Ioannina, Rethimno and Chania.

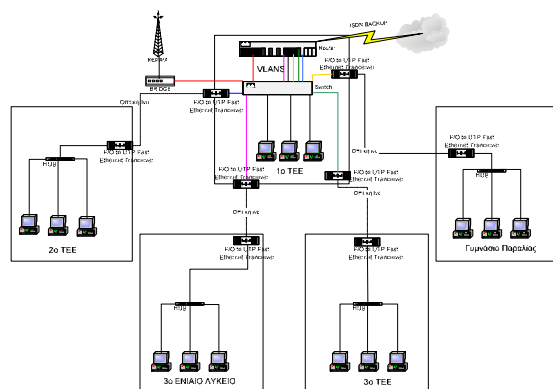

Wireless school network of Kalamata

The available bandwidth of the networks mentioned above allows for the provision of advanced and high quality telecommunication and informatics services to the units concerned, as well as significant lowering of the telecommunication costs.

8. Greek Schools Network Implementation Scheme















The contribution of Research Centers, Universities and Technological Education Institutes under the supervision of the Ministry of Education has been critical in the implementation and operation of the Greek Schools Network.

This cooperation has guaranteed both the equal coverage of all geographical apartments of Greece, as well as the immediate users' support by proximate institutions. In addition, it promotes the creation and consolidation of solid relationships amongst all educational degrees, while assuring the transfer of technical knowledge to the Ministry of Education permanent structures, contributing to the viability and the permanency of the attempted interventions.

In particular, the cooperating institutions see to:

- Monitor the implementation as well as the qualitative and quantitative acceptance of network structure development projects in educational and administrative units of the first and second educational degree.
- Provide and administrate telecommunications and informatics services
- Administrate the core and distribution network
- Offer technical support to the network's users
- Hold competitions of bids for acquiring network equipment

The following institutions participate in the implementation and operation of the GSN:

	Ministry of Education and Religious Affairs www.ypepth.gr		Research and Academic Computer Technology Institute (R.A.C.T.I.), www.cti.gr
	Institute of Communication and Computer Systems (ICCS/NTUA), www.iccs.ntua.gr		Aristotle University of Thessaloniki, www.auth.gr
	Democritus University of Thrace, www.duth.gr		National & Kapodistrian University of Athens, www.uoa.gr
	Aegean University, www.aegean.gr		University of Thessaly, www.uth.gr
	University of Ioannina, www.uoi.gr		University of Crete, www.uoc.gr
	University of Macedonia, www.uom.gr		Technological Education Institute of Athens, www.teaith.gr
	Technological Education Institute of Thessaloniki, www.teithe.gr		Internet Service Provider: Greek Research and Technology Network, www.grnet.gr

Communication info: <http://www.sch.gr>, email: info@sch.gr